

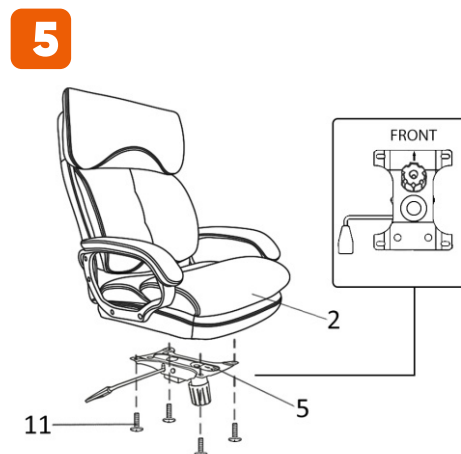

# Chairman 505

**RU** ИНСТРУКЦИЯ ПО СБОРКЕ  
**EN** ASSEMBLY INSTRUCTIONS  
**DE** AUFBAUANLEITUNG  
**FR** INSTRUCTIONS DE MONTAGE  
**IT** MANUALE D'USO  
**ES** INSTRUCCIONES DE MONTAJE  
**CS** NÁVOD K MONTÁŽI  
**KK** ЖИНАУ ЖӨНІНДЕГІ НҰСҚАУЛЫҚ

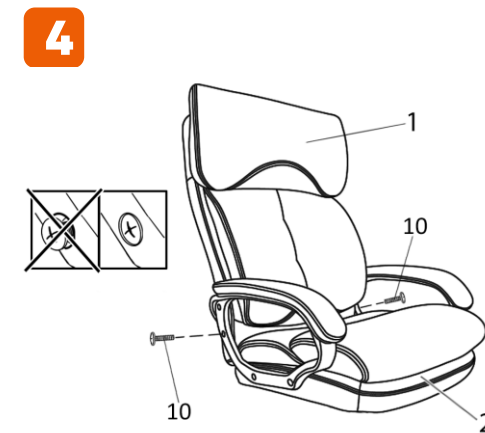
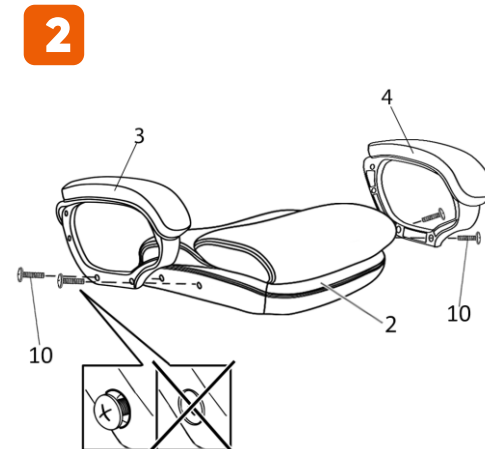
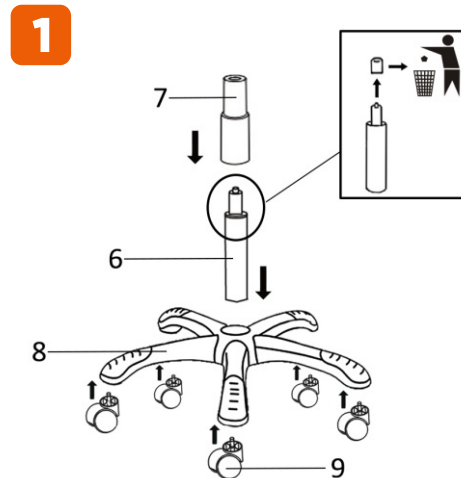
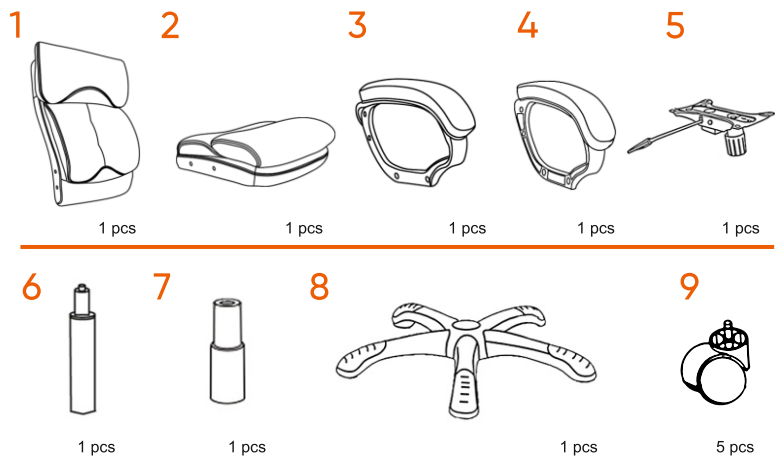

**STEP 1**  
 ↓  
**STEP 2**

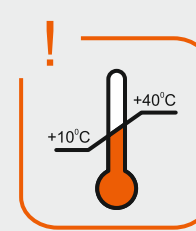
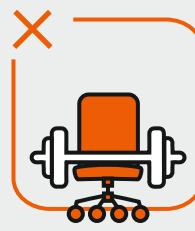
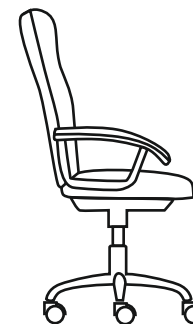
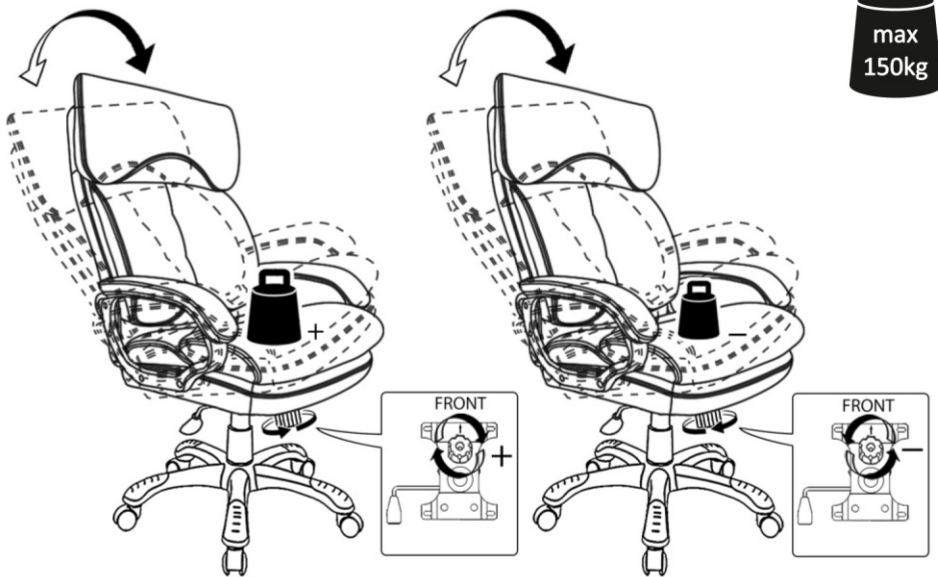
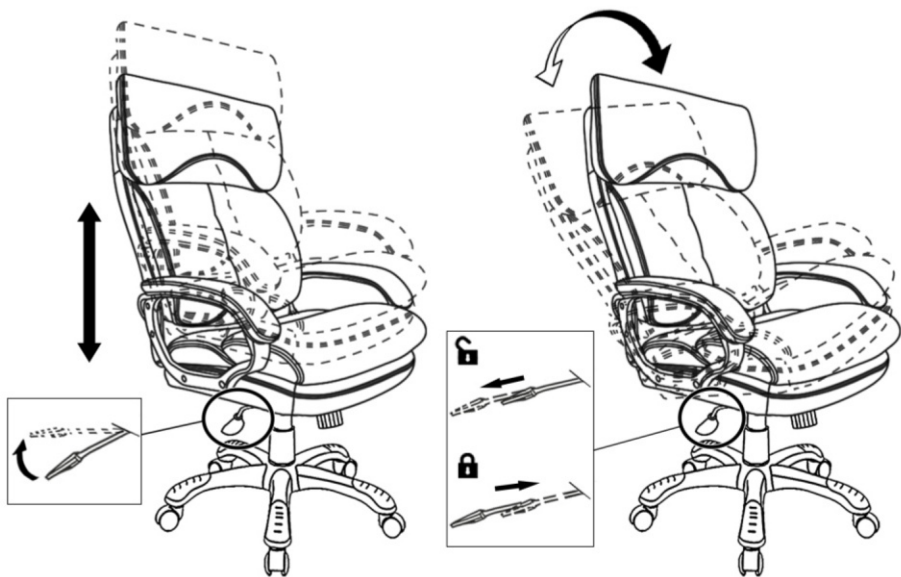

**CHAIRMAN**  
ПОМОГАЕТ РАБОТАТЬ

🌐 [chairman.ru](http://chairman.ru)

✉ [info@chairman.ru](mailto:info@chairman.ru)

📺 [vk.com/chairman\\_chairs](https://vk.com/chairman_chairs)